

► SPECIFICATIONS

Alldrive 1 Tonne Hi-Tip

HYDROSTATIC

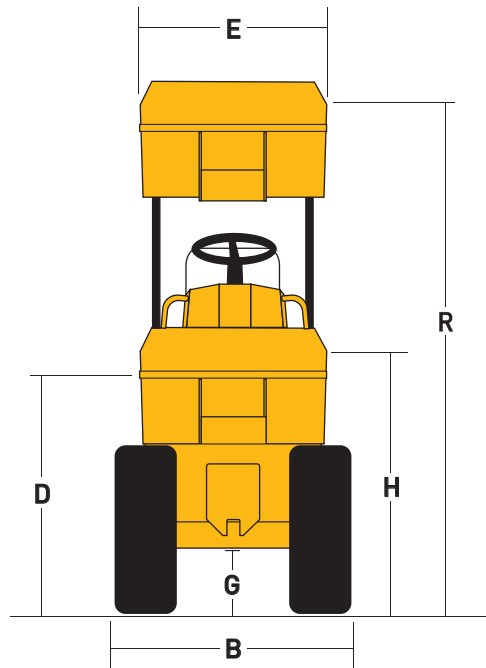
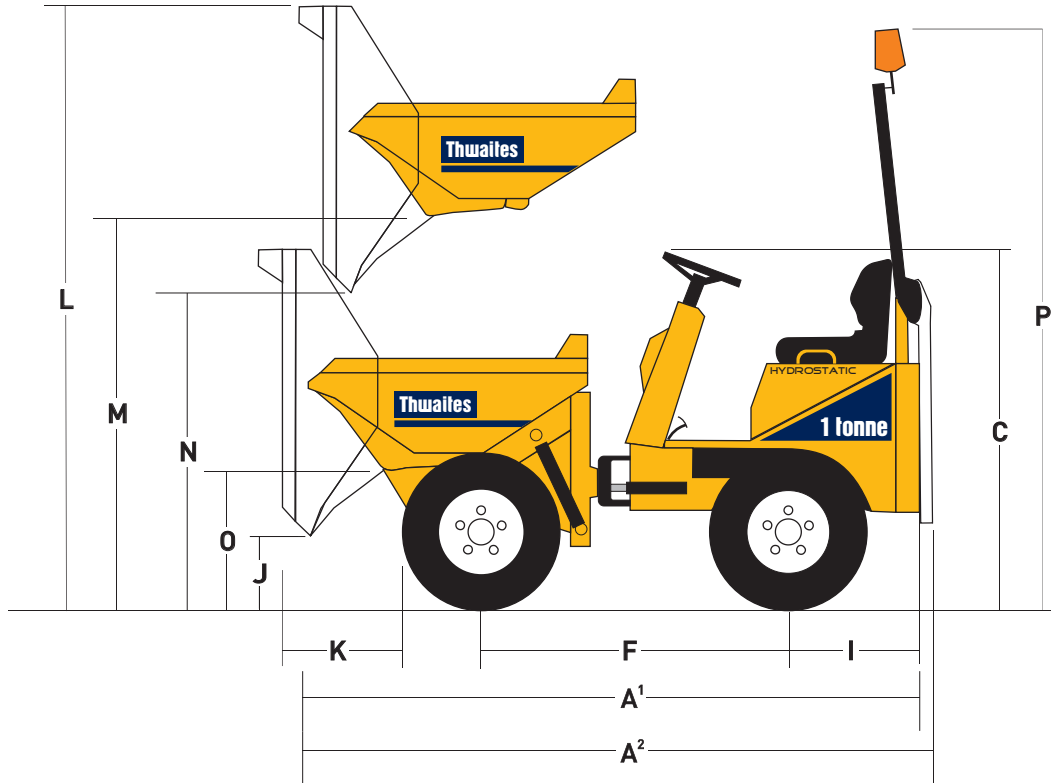

**Dimensions
(mm)**

A ¹	3032
A ²	3192
B	1115 (982*)
C	1773
D	1155
E	982
F	1500
G	274
H	1262
I	654
J	346
K	505
L	3005
M	1913
N	1573
O	720
P	2860
R	2370

*with optional narrow wheels

► SPECIFICATIONS

Alldrive 1 Tonne Hi-Tip

HYDROSTATIC

Capacities	Max. safe load	1000 kg
	Heaped	500 litres
	Struck	400 litres
	Water	280 litres

Engine

Yanmar 3TNV76, 15.9 kW/21.4 bhp (nett) @ 2800 rpm, three-cylinder water-cooled diesel. Max torque 66.4 Nm (49 lb f ft). Electric starting, hour meter, battery isolator switch and heavy-duty cyclonic air cleaner positioned within the lockable engine compartment.

Noise Levels

Operator's ear 84 LpA, airborne sound power level 101 LwA (to 2000/14/EC).

Speeds	Forward/reverse:	0-12 km/h
--------	------------------	-----------

Tyres	Standard	Optional
	10.0/75 x 15.3	7.00 x12
	8 ply	6 Ply
	Track grip tread	Track grip tread

Brakes

Automatic failsafe braking system incorporated into rear drive motors.

Chassis

Front and rear chassis constructed from folded steel plate, with centre-point articulation and oscillation for optimum stability and traction.

Drive System

Hydrostatic with variable displacement pump feeding four wheel motors, incorporating "Twin-Lock" system to maximise traction.

Skip

Hydraulically operated, 3 mm base, 4 mm sides steel plate. Mouth reinforced with box sections giving greater strength to minimise damage, no material traps. Raise and tip control operated by twin control levers.

Seating & Controls

Column-mounted forward/reverse lever with foot pedal speed control. Adjustable suspension seat, accessible from both sides. Audible warning device at key start 'on' position. Super-bright warning lights for all critical functions. Electric horn.

Service Access

Lockable three-sided cover provides easy access from ground level to engine service points.

Electrics

Wiring harness contained within conduits and all electrical components water resistant to IP65/67 standards.

Steering & Hydraulics

Hydraulic power steering. Return line filtration for all services and large capacity suction strainer in the tank to give full circuit protection. Hydraulic test point fitted as standard.

Tank Capacities	Fuel	21 litres
	Hydraulic	20 litres

Shipping Cube	6.3 m ³ (with folded ROPS)
---------------	---------------------------------------

Unladen Weight	1295 kg
----------------	---------

Clearance Diameter	5.45 m
--------------------	--------

ROPS/Beacon

A folding ROPS bar and beacon are fitted as standard.

Optional Extras

Full road lighting equipment. Reverse alarm. UK road equipment. Towing bracket. Grassland/sand tyres and narrow tyres.

Thwaites

Thwaites Ltd. Leamington Spa, Warwickshire CV32 7NQ, England
Tel +44 (0)1926 422471 Fax +44 (0)1926 337155
www.thwaitesdumpers.co.uk

Distributor



We reserve the right to change all specifications without prior notice.
Printed in England 03/05